

WT588F02B-8S

Voice Chip Specification

Version : V1.05

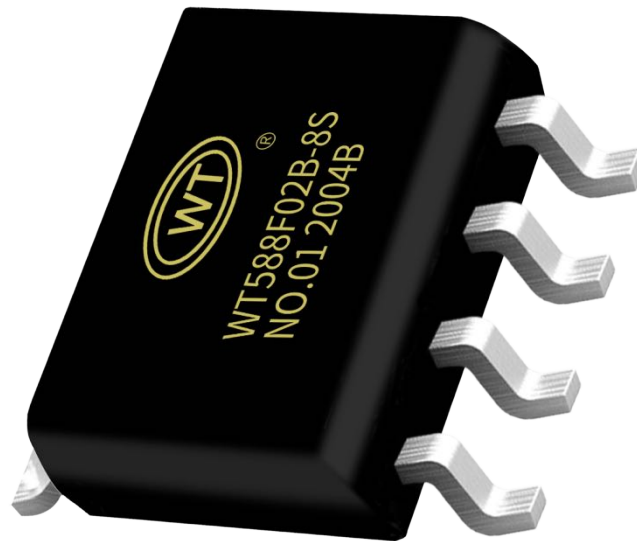

Note :

WAYTRONIC ELECTRONIC CO.,LTD. reserves the right to change this document without prior notice. Information provided by WAYTRONIC is believed to be accurate and reliable. However, WAYTRONIC makes no warranty for any errors which may appear in this document. Contact WAYTRONIC to obtain the latest version of device specifications before placing your orders. No responsibility is assumed by WAYTRONIC for any infringement of patent or other rights of third parties which may result from its use. In addition,WAYTRONIC products are not authorized for use as critical components in life support devices/systems or aviation devices/systems, where a malfunction or failure of the product may reasonably be expected to result in significant injury to the user, without the express written approval of WAYTRONIC.

Product Introduction.....	1
1. Overview	2
2. Function Description	2
3. Pin Description.....	3
3.1. Pin Distribution Diagram	3
4. Limit Parameter.....	4
5. Electrical Characteristics.....	4
6. One-line Serial Communication.....	5
6.1. Pin Assignment.....	5
6.2. One-line Audio Address Corresponding Relation.....	5
6.3. One-line Audio and Command Code	6
6.4. One-line Serial Port Sequence Diagram	7
7. Two-line Serial Port Communication.....	8
7.1. Pin Distribution	8
7.2. Audio Address Corresponding Relation.....	9
7.3. Two-line Audio and Command Code.....	9
7.4. Two-line Serial Port Sequence Diagram	11
8. Program Example.....	12
8.1. One-line Serial Port Control Program(Single Byte Instruction).....	12
8.2. One-line Serial Control Program (F3+01+F3+02+F3+03)	13
8.3. Two-line Serial Port Control Program(Single Byte Instruction).....	14
8.4. Two-line Serial Port Control Program (F3+01+F3+02+F3+03)	15
9. Online Downloader	15
9.1. Download Schematic	16
9.2. Downloader Instructions	17
10. Package Pin Diagram	19

Product Introduction

Voice Updating

1. Online update: save the bin file to the online downloader, and connect the device through the online downloader to change the voice. The operation is convenient and fast, and it can be used for the voice replacement of the PCB board.

Storage method

1. There is 220K byte storage space inside the chip (not including the main control program)
2. The chip main control program and internal storage space can be repeatedly erased and written

Play Mode

1. PWM output: 16-bit PWM pure audio output, which can directly drive 8Ω/0.5W speakers and buzzers,
2. DAC output: 14-bit DAC audio output, can be connected to an external power amplifier
3. Support up to 4 channels 16K sampling rate mixing
4. Supports up to 16-channel midi playback (8K sampling rate);
5. Support seamless connection function (audio source needs to be processed, please contact the salesman)
(PWM and DAC output can be set by bin file)

Audio sampling rate

Support 6~32Khz

Control Method

1. One-line serial port control/two-line serial port control
2. Button function control (functions can be customized according to the actual situation) (The main control program of serial port control and button control is different, please contact the salesman when placing an order)

Operation Instruction

1. Volume adjustment instructions
2. Loop play instruction
3. Play fixed voice commands
4. Play pause command

Technical Specifications

1. Power supply voltage DC2.0~5.5V
2. Working temperature -20~75 degrees
3. Humidity 5%~95%

Application scenarios

1. Devices that require change voice frequently
2. Outdoor equipment that needs to change the voice content



1. Overview

WT588F02B-8S is a 16-bit DSP voice chip newly developed by Shenzhen Waytronic Electronics Co., Ltd., internal oscillation 32Mhz, 16-bit PWM decoding. Powerful functions make WT588F02B-8S a leader in the voice chip industry. At present, WT588F02B-8S can store up to 170 seconds of voice content with higher sound quality (if the customer has no requirements for sound quality, it can store up to 320 seconds of voice content). WT588F02B-8S is different from the traditional OTP chip. The biggest breakthrough is that customers can replace the internal voice content of the chip online through the supporting downloader; and the chip has built-in hardware SPI, UART, IIC, comparator and other resources, which can be customized a variety of personalized functional products.

2. Function Description

1. 16-bit DSP voice chip, 32Mhz internal oscillation
2. Working voltage 2.0~5.5V
3. 16bit PWM/DAC output, can directly drive 8R 0.5W speakers
4. Support WAV files of 6K~32Khz
5. Customers can **replace the internal voice content of the chip online** through the supporting downloader;
6. Support one-line serial port and two-line serial port (spi communication will come out one after another);
7. Support up to 4 channels of 16K sampling rate mixing
8. Support up to 16 channels of midi playback (8K sampling rate)
9. Support 224 segment addresses, which can be expanded with more requirements
10. With hardware SPI interface, UART interface, IIC, built-in comparator and other interfaces. Various functions can be customized for customers
11. There is 220K byte storage space inside the chip (not including the main control program).
12. The chip main control program and built-in storage data can be erased and re-programmed
13. The chip power-on initialization time is about 200ms

14. After the chip playing is over, and the IO ports (DATA and CLK) maintain a stable level (both high and low levels) for 1 second, the chip enters sleep

Selection Attention:

1. The control mode and output mode of the chip can be set by the bin file, and the application requirements should be explained to the salesperson when ordering the chip.
2. If you need a chip with lower standby power consumption, please contact our salesperson.

3. Pin Description

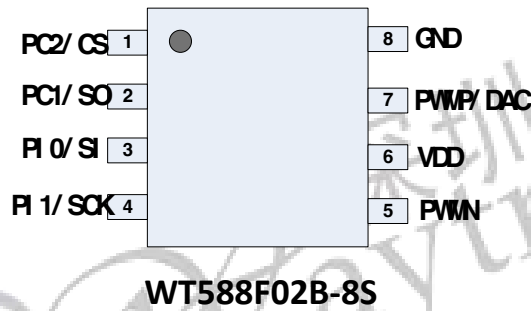

3.1. Pin Distribution Diagram

Pad Name	Pad No.	ATTR.	Description
PC2/BUSY/CS	1	I/O	Output the busy signal/downloader programming port
PC1/DATA1/CLK2/SO	2	I/O	one-line serial port data signal input terminal/Two-line serial port clock signal input terminal/downloader programming port
PI0/DATA2/SI	3	I/O	two-line serial port data signal input terminal/downloader programming port
PI1/SCK	4	I/O	downloader programming port
PWMN	5	out	PWMoutput pin
VDD	6	Power	Positive electrode
PWMP	7	I/O	PWM output pin/DAC
GND	8	Power	Negative electrode

4. Limit Parameter

Mark	range	unit
VDD~GND power supply voltage	-0.5~+5.5	V
Vin input voltage	GND-0.3 < Vin < VDD+0.5	V
Vout output voltage	GND < 0.3V ~ VDD+0.3	V
Top work temperature	-20~ +85	°C
Storage temperature	-50~100	°C

Remarks: As a result of the samples tested in the laboratory, the chip can work normally at -40°C~+85°C.

5. Electrical Characteristics

Parameters	sign	minimum	typical value	Maximum	test condition
Working voltage	VCC	2.0V		5.5V	
Oscillation frequency	Fbank0	4.096MHz±3%		8.192MHz±3%	
Oscillation frequency(BANK 7)	Fbank7		32.768MHz±3%		
RC oscillator frequency	Frc 1		65.536 MHz±3%		
Low power rc oscillator frequency	frc 2	32768hz-5%		32768hz 15%	
Working current	IOP		5mA		No load
IO port logic level(H)	VIH	0.8 VCC			
IO port logic level(L)	VIL			0.2VCC	
	ILK			0.1 UA	
IO port output level (H)	VOH	0.95VCC			No load
IO port output level (L)	VOL			0.05V	No load
IO port drive current	IOH		16mA		VOUT=VCC-0.4V , PA select intensity drive option
IO leakage current	IOL		-16 mA		Vout=0.4V PA select intensity drive option

IO port pull-down resistance	RPD	50K/220 K/1M/infinity Can choose configuration Default 1M internal pull-down resistance	Pull-down pin , PA
------------------------------	-----	---	--------------------

6. One-line Serial Communication

One-line serial port mode can use MCU to send data to WT588F series voice chip through DATA line to achieve the purpose of control. It can control voice playback, stop, loop, etc. One-line serial port control only needs one IO port, and the shortest time for an instruction is 8.2ms ($5ms+(0.1ms+0.3ms)*8=8.2ms$). Detailed description can be seen below

6.1. Pin Assignment

package	pin	
	PC1	PC2
SOP8	DATA	BUSY

6.2. One-line Audio Address Corresponding Relation

Data(hexadecimal)	Function
00H	Play the 0th voice
01H	The 1 st audio play
02H	The 2 nd audio play
.....	
DDH	The 221 st audio play
DEH	The 222 nd audio play
DFH	The 223 rd audio play

Note: If you want to play the voice of this address, you can automatically play the voice of this address as long as you send the address. The time interval between the two address commands must be greater than 4ms.

6.3. One-line Audio and Command Code

Command code	Function	Description
E0H...EFH	E0 is the minimum volume; EF is the maximum; 16-level volume is adjustable in total.	Send this command to adjust the volume at the end of the voice playback, during playback or in standby mode.
F1H	Seamless loop playback instructions,(If the sound source needs to be adjusted accordingly, please contact our salesperson for details)	Execute this command to play the current voice in a loop, and it can be sent while the voice is playing. During the execution of F1 loop command, it can be interrupted by FE command, ordinary address command, and F3/F8 combined command, and it becomes invalid; the playback command must be sent first, and then the loop playback command. Send F1 again to stop the current cycle function
F2H	Repeat to play the current audio	Execute this command to play the current voice in a loop, and it can be sent while the voice is playing. During the execution of the F2 loop command, it can be interrupted by the FE command, the ordinary address command, and the F3/F8 combined command, and becomes invalid; the playback command must be sent first, and then the loop playback command. Send F2 again to stop the current cycle function
F3H	Code-linking play	F3H+Voice address A, F3H+Voice address B, F3H+Voice address C,... When playing address A, it does not interrupt when receiving the following code. After playing A, it will play B, and then play C.... A 2ms delay is required between F3 and the address. The interval between one set of coded addresses and the next set of addresses must be greater than 2ms ("F3+Voice Address" is a set of coded addresses), and up to 40 segments of coded addresses can be realized.
FEH	Stop playing the current audio	Execute this command to stop playing the current voice.

Note:

- Without stopping the playback, if there is no command code F3H and only a voice address, the voice that is being played will be interrupted. The consecutive code commands must be used with the address (for example: F3H+00H+F3H+01H). F3H can easily combine different voices. F3H+address A+F3H+address B can combine up to 40 groups of content; it can also complete the combined playback by judging the BUSY level when the voice is played and the change of the BUSY level at the end of the playback.
- Because the WT588F voice initialization time takes a long time and cannot respond to commands during initialization, it is recommended that users use the code-linking function to send a set of code-linked addresses and then delay 2ms before sending the next set of code-linked addresses.

6.4. One-line Serial Port Sequence Diagram

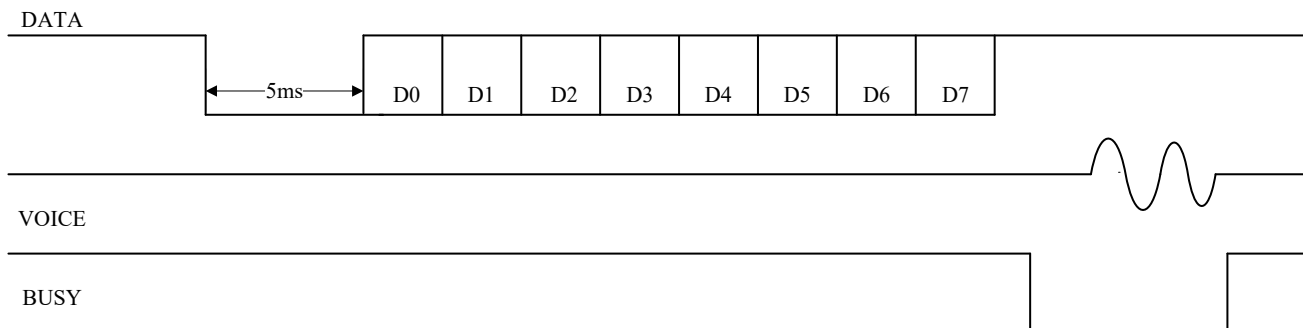

Pull data line low to 5ms (the time range is 5ms-20ms), then send 8-bit data, low bit first, then high bit. Use the ratio of high level and low level to represent the value of each data bit.

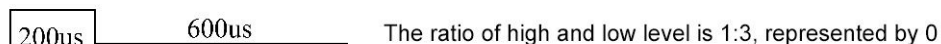

Note:

The high level must be in front and the low level in the back.

It is recommended to use 200us: 600us. Value range: 100us:300us ~ 400us:1200us. It is recommended to use 3:1 and 1:3 level ratios (the level ratio range is 3:1~5:1, 1:3~1:5) to ensure stable communication.

If we want to send 96H, then his corresponding sequence diagram is as follows:

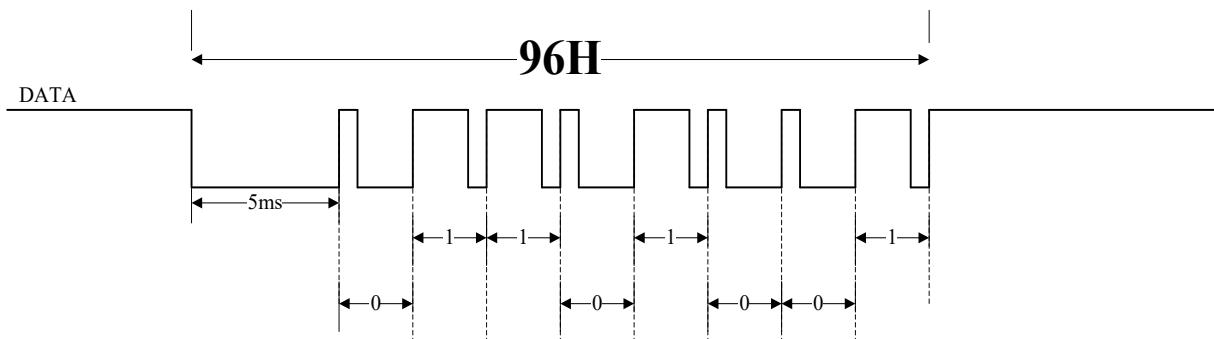

If we want the chip to play the voice content of address 01/02/03/04 in sequence. That is, the code-linking command playback, F3+01+F3+02+F3+03+F3+04. The corresponding sequence diagram can be shown as

follows:

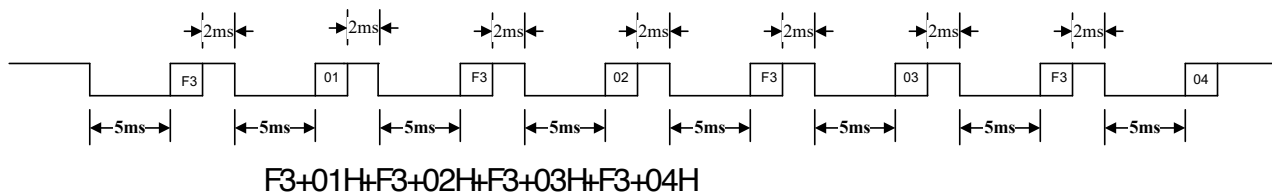

Note:

1. The power-on initialization time of the WT588F voice chip is about 200ms, and it cannot respond to commands during initialization;
2. There should be an interval of 2ms between the F3 command and the address during code-linking playback, please refer to the figure above;
3. Chip IO port, default internal 1M pull-down. Therefore, when the customer is doing low-power sleep, the DATA can be pulled low after playback to prevent backflow; if the DATA is pulled low, the DATA must be pulled high for more than 3ms before sending the command before sending the command.

7. Two-line Serial Port Communication

Two-line serial port mode can use MCU to send data to WT588F series voice chip through DATA line and CLK line to achieve the purpose of control. It can control voice playback, stop, loop, etc. The two-wire serial port control method has good anti-interference ability, and the shortest time of an instruction is 6.6ms (5ms+0.2ms*8=6.6ms). Detailed description can be seen below.

7.1. Pin Distribution

package	pin		
	PC2	PC1	PI0
SOP8/DIP8	Default to BUSY signal output port	CLK	DATA

7.2. Audio Address Corresponding Relation

Data(hexadecimal)	Function
00H	Play the 0th voice
01H	The 1 st audio play
02H	The 2 nd audio play
.....	
DDH	The 221 st audio play
DEH	The 222 nd audio play
DFH	The 223 rd audio play

Note:

If you want to play the voice of this address, you can automatically play the voice of this address as long as you send the address. The time interval between the two address commands must be greater than 4ms.

1. Because WTN6 needs a certain initialization time (about 100MS) to power on, and it cannot respond to commands during initialization, it is recommended that users use the code-linking function to send a group of coded addresses and then delay 2ms before sending the next group of coded addresses. ; But the interval between F3 and the address is still 2ms;
2. The chip IO port, the default internal 1M pull-down. Therefore, when the customer is doing low-power sleep, the voice playback can pull down CLK and DATA to prevent backflow.

7.3. Two-line Audio and Command Code

Command code	Function	Description
E0H...EFH	E0 is the minimum volume; EF is the maximum; 16-level volume is adjustable in total.	Send this command to adjust the volume at the end of the voice playback, during playback or in standby mode.
F1H	Seamless loop playback instructions; (If the sound source needs to be adjusted accordingly, please contact our salesperson for details)	Execute this command to play the current voice in a loop, and it can be sent while the voice is playing. During the execution of F1 loop command, it can be interrupted by FE command, ordinary address command, and F3/F8 combined command, and it becomes invalid; the playback command must be sent first, and then the loop playback command. Send F1 again to stop the current cycle function
	Repeat to play the current audio	Execute this command to play the current voice in a loop, and it can be sent while the voice is playing. During the execution of the F2 loop command, it can be interrupted by the FE command, the

F2H		ordinary address command, and the F3/F8 combined command, and becomes invalid; the playback command must be sent first, and then the loop playback command. Send F2 again to stop the current cycle function
F3H	Code-linking play	F3H+Voice address A, F3H+Voice address B, F3H+Voice address C,... When playing address A, it does not interrupt when receiving the following code. After playing A, it will play B, and then play C.... A 2ms delay is required between F3 and the address. The interval between one set of coded addresses and the next set of addresses must be greater than 2ms ("F3+Voice Address" is a set of coded addresses), and up to 40 segments of coded addresses can be realized.
FEH	Stop playing the current audio	Execute this command to stop playing the current voice.

In the count pulse control sequence, first pull up the RESET signal by 150us, and then send DATA. The high level of the pulse in DATA needs to be maintained at a high level of 100us, and the interval between two pulses needs to be 100us. 64ms after the pulse data is sent, the BUSY signal is output. After BUSY output 100us, it will start to play the address voice, and the BUSY will also change after the voice playback.

Note: The pulse signal high-level width time range: 50us~2ms, 100us is recommended; the pulse signal interval time range: 100us~4ms, 100us is recommended. The high level range of the reset signal is greater than 100us, and 150us is recommended. The communication IO port is usually low, and it should be pulled low after sending the data.

Note:

1. Without stopping the playback, if there is no command code F3H and only a voice address, the voice that is being played will be interrupted. The consecutive code commands must be used with the address (for example: F3H+00H+F3H+01H). F3H can easily combine different voices. F3H+address A+F3H+address B can combine up to 40 groups of content; it can also complete the combined playback by judging the BUSY level when the voice is played and the change of the BUSY level at the end of the playback.
2. Because the WT588F voice initialization time takes a long time and cannot respond to commands during initialization, it is recommended that users use the code-linking function to send a set of code-linked addresses and then delay 2ms before sending the next set of code-linked addresses.

7.4. Two-line Serial Port Sequence Diagram

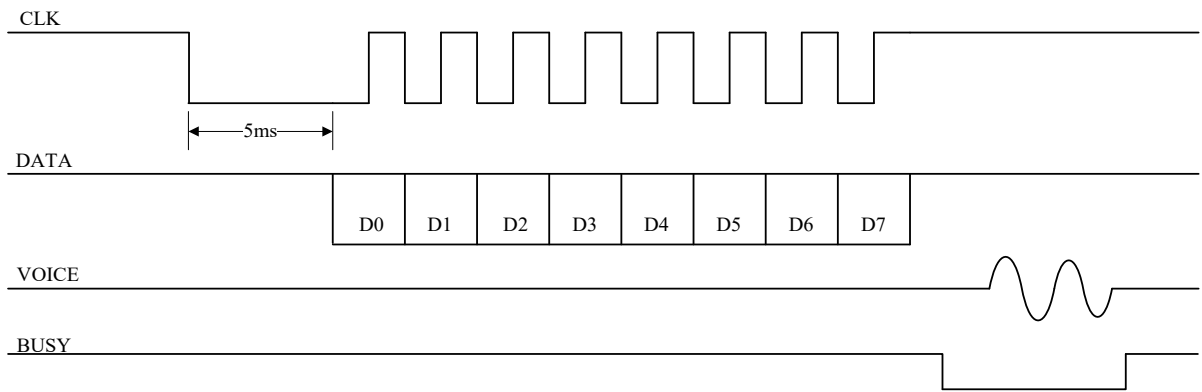

The two-line serial port control mode is controlled by the chip clock CLK and data DATA. Before each byte of data is sent, the clock signal CLK is pulled down 4ms to 20ms, and 5ms is recommended. Receive data low bit first, receive data on the rising edge of the clock. The clock cycle is between 200us and 3.2ms, and the recommended cycle is 300us. When sending data, send the low bit first, then the high bit. 00H~DFH in the data are voice address commands, E0H~EFH are volume adjustment commands, F2H is a loop playback command, and FEH is a stop playback command.

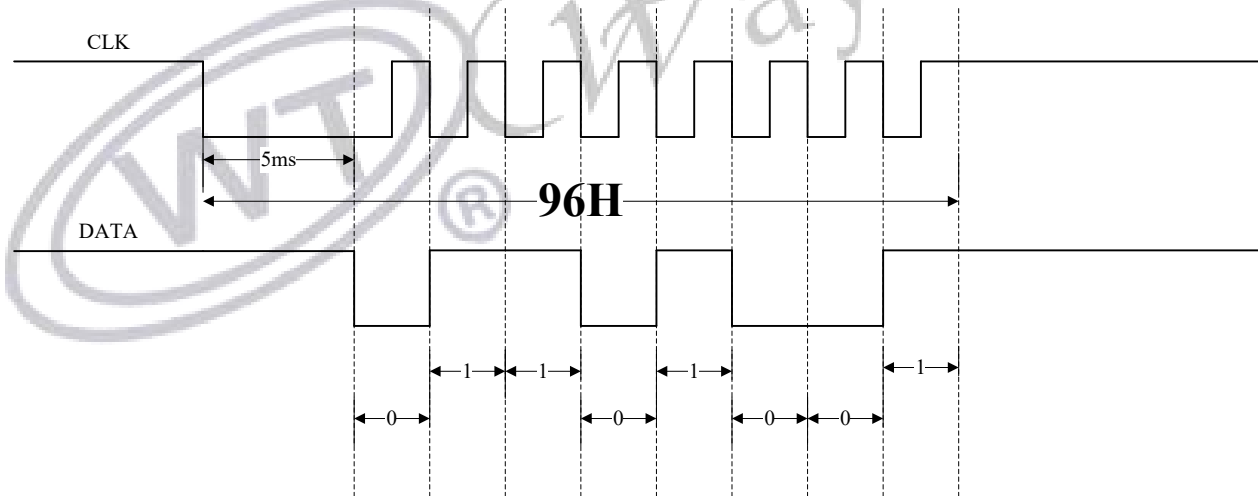

If we want the chip to play the voice content of address 01/02/03/04 in sequence. That is, the code-linking command playback, F3+01+F3+02+F3+03+F3+04. The corresponding sequence diagram can be shown as follows:

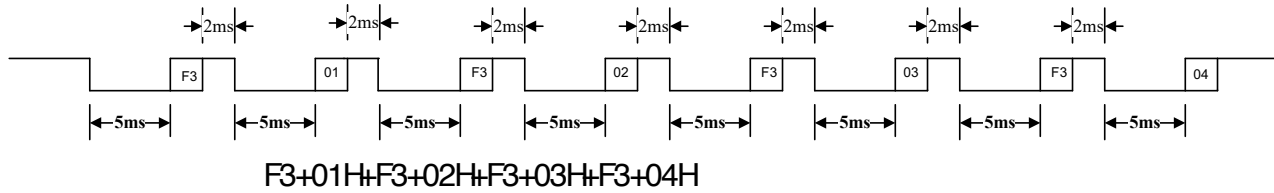

Remark:

1. Since the WT588F voice chip power-on initialization time is about 200ms, it cannot respond to commands during initialization;
2. There should be an interval of 2ms between the F3 command and the address during continuous code playback, please refer to the figure above;
3. Chip IO port, default internal 1M pull-down. Therefore, when the customer is doing low-power sleep, the CLK and DATA can be pulled down after playback to prevent backflow; if the CLK is pulled low, the CLK must be pulled high for more than 3ms before sending the command before sending the command.

8. Program Example

8.1. One-line Serial Port Control Program(Single Byte Instruction)

```

#define UC8    unsigned char
#define P_DATA P01
/*-----
; Module name: Line_1A_WT588F(UC8 DDATA)
;Function: Realize a serial port communication function
; Input parameters: DDATA is sending data
;Output parameters:
; P_DATA is the data port;-----*/
Void Line_1A_WT588F( UC8  DDATA)
{
    UC8  S_DATA,j;
    bit   B_DATA;

    S_DATA =  DDATA;
    P_DATA = 0;
    Delay_1ms(5);    //delay 5ms
    B_DATA = S_DATA&0X01;

    for(j=0;j<8;j++)
    {

```

```

if(B_DATA == 1)
{
    P_DATA = 1;
    Delay_N10us(60);    //delay 600us
    P_DATA = 0;
    Delay_N10us(20);   //delay 200us
}
else
{
    P_DATA = 1;
    Delay_N10us(20);   //delay 200us
    P_DATA = 0;
    Delay_N10us(60);   //delay 600us
}
S_DATA = S_DATA>>1;
B_DATA = S_DATA&0X01;
}
P_DATA = 1;

```

8.2. One-line Serial Control Program (F3+01+F3+02+F3+03)

```

/*-----
; Module name: List_1A_Play_WT588F()
; Function: Realize the function of sending one-line serial code-linking
; Input parameters: DDATA is sending data
;output parameters:;-----*/

Void List_1A_Play_WT588F( void )
{
Line_1A_WT588F( F3 );
Delay_1ms(2);          //delay 2ms
Line_1A_WT588F( 01 );
Delay_1ms(2);
Line_1A_WT588F( F3);
Delay_1ms(2);
Line_1A_WT588F( 02 );
Delay_1ms(2);
Line_1A_WT588F( F3 );
Delay_1ms(2);
Line_1A_WT588F( 03 );
Delay_1ms(2);
}

```

8. 3. Two-line Serial Port Control Program(Single Byte Instruction)

```

#define UC8    unsigned char
#define CLK_2A    P01
#define P_DATA_2A P00

/*-----
; Module name: Line_2A_WT588F(UC8 DDATA)
;Function: Realize two-line serial communication function
; Input parameters: DDATA is sending data
; Output parameters:
; CLK_2A //clock line
; P_DATA_2A //Data line;-----*/
Void Line_2A_WT588F(UC8 DDATA)
    P_DATA = 1;
}
{
    UC8 S_DATA,j;
    bit B_DATA;
    CLK_2A = 1; //CLOCK LINE
    P_DATA_2A = 1; //DATA LINE

    S_DATA = DDATA;
    CLK_2A = 0;
    Delay_1ms(5); //delay 5ms
    B_DATA = S_DATA&0X01;

    for(j=0;j<8;j++)
    {
        CLK_2A = 0; // pull-down
        P_DATA_2A = B_DATA; //Transmission data one bit

        Delay_N10us(30); //delay 300us
        CLK_2A = 1; //pull-on
        Delay_N10us(30); //delay 300us

        S_DATA = S_DATA>>1;
        B_DATA = S_DATA&0X01;
    }
    P_DATA_2A = 1;
    CLK_2A = 1;

```

8. 4. Two-line Serial Port Control Program (F3+01+F3+02+F3+03)

```
/*-----  
; Module name: List_2A_Play_WT588F()  
;Function: realize the function of sending two-line serial port with code-linking  
; Input parameters: DDATA is sending data  
;Output parameters:;-----*/  
  
Void List_2A_Play_WT588F( void )  
{  
Line_2A_WT588F( F3 );  
Delay_1ms(2); //delay 2ms  
Line_2A_WT588F( 01 );  
Delay_1ms(2);  
Line_2A_WT588F( F3 );  
Delay_1ms(2);  
Line_2A_WT588F( 02 );  
Delay_1ms(2);  
Line_2A_WT588F( F3 );  
Delay_1ms(2);  
Line_2A_WT588F( 03 );  
Delay_1ms(2);  
}
```

9. Online Downloader

Save the bin file in the online downloader, and connect the device through the online downloader to replace the voice. It can be used for production or client device voice replacement. It is convenient, fast and simple to operate, and is suitable for devices that require frequent voice replacement. (The online downloader has a video explanation, you can contact the salesperson to provide it.)

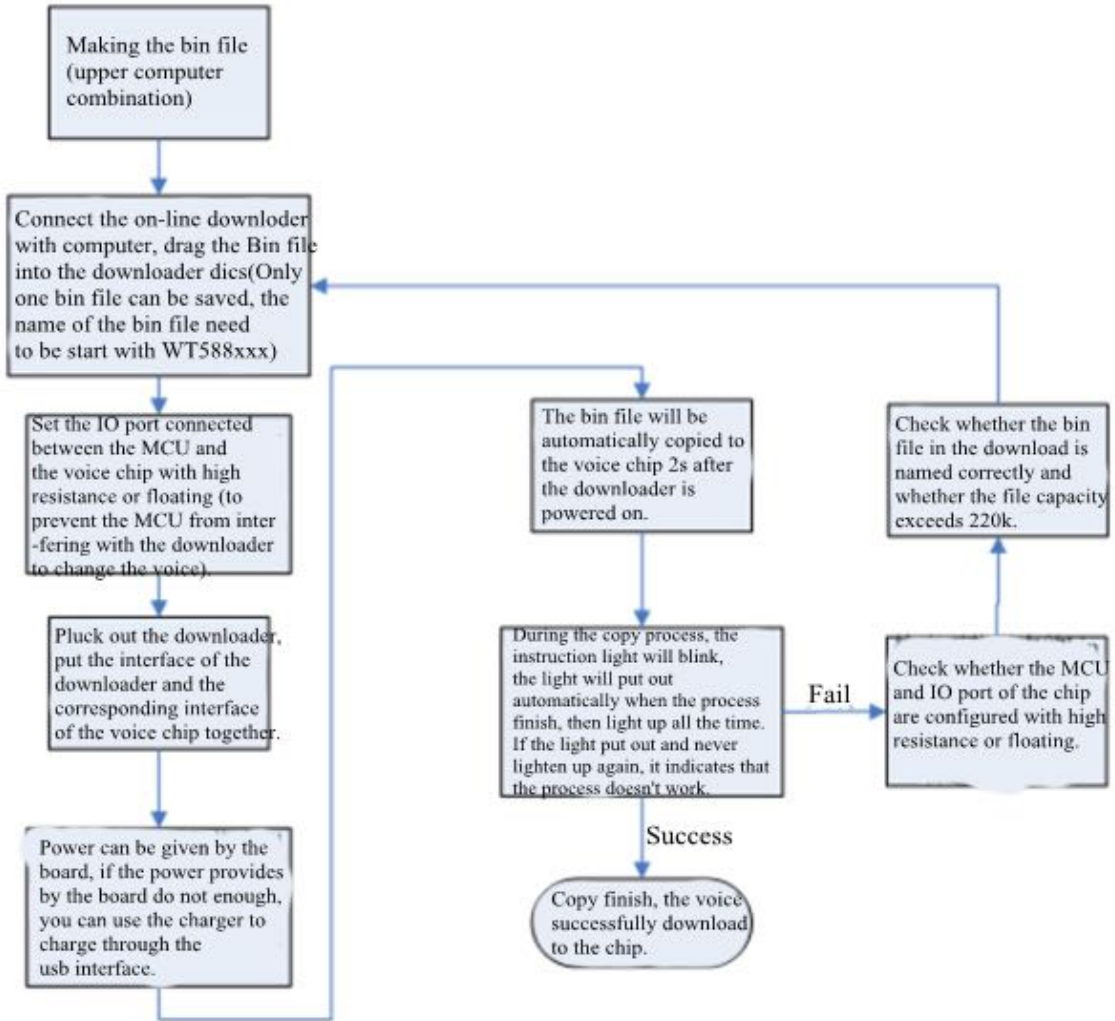

9.1. Download Schematic

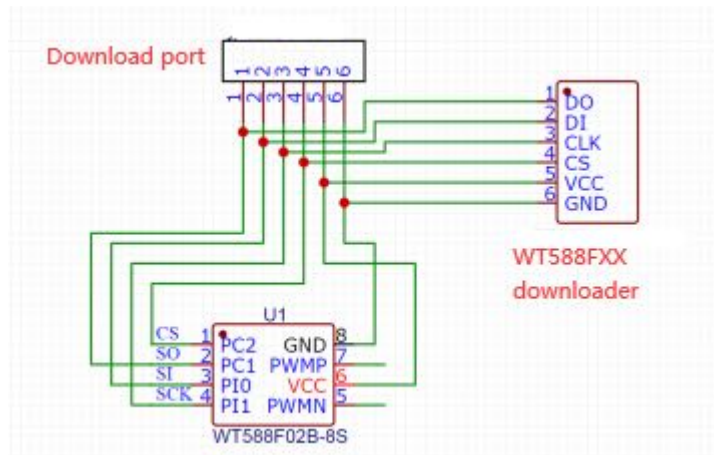

9.2. Downloader Instructions

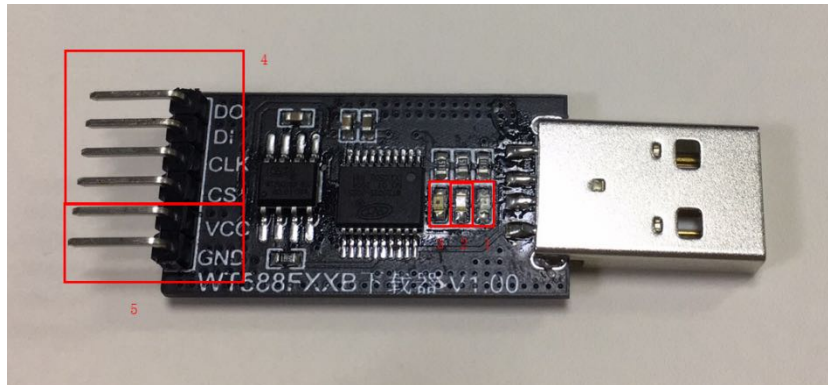

(1) Making a bin file: After logging in to the host computer URL of the webpage, load the voice file to be played or use the text-to-audio function to load the voice and make the bin file. WT588 webpage creation customer login URL: <http://WT588f.waytronic.com:8083/user/register>. For the steps of making bin files, please refer to <<WT588F Web Host Computer Operating Instructions 2020-8-31>> or video explanations, which can be provided by contacting the salesperson.

(2) Store the bin file: connect to the computer via USB, a drive letter will appear (formatting for the first use), save the bin file into the drive letter, and the bin file name format should be WT588XXX (beginning with WT588) , Can be defined later). After the Bin file is stored, disconnect the downloader from the computer.

(3) Connect the chip: Let the microcontroller release the voice chip, and set the IO port of the microcontroller connected to the voice chip as input or floating; connect the programming port of the downloader (that is, the 4 pins of box 4) to the corresponding voice chip IO ports (DO-PC1, DI-PI0, CLK-PI1, CS-PC2, VCC-VCC, GND-GND), the customer can leave a download port on the board when drawing the board, which is convenient for downloading and replacing the voice.

(4) Powering the downloader: Box 5 is the power supply pin. When the customer board has power supply, the downloader can be powered through the VCC and GND pins; if the customer board is not powered, it can be powered by USB (adapter or computer USB can be used for power supply (generally It is not recommended to use the computer's USB power supply)) to supply power to the downloader and chip; if the

board has a download port according to the above schematic diagram, you can directly plug the downloader into the download port for programming.

(5) Automatic downloading: 2s after the downloader is powered on, the downloader will automatically download the bin file to the voice chip (so you need to connect the download port before supplying power to the downloader).

(6) Download judgment: 1 power indicator, 2 copy indicator, 3 status indicator.

The power indicator light is always on to indicate that the product is already in working condition.

The copy indicator is usually off, flashes during the copying process, and then goes out after the copy is over.

The status indicator is usually off, the copy is successful and always on, and the copy fails.
(The online downloader has a video explanation, you can contact the salesperson to provide it.)



10. Package Pin Diagram

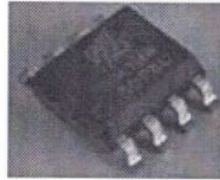
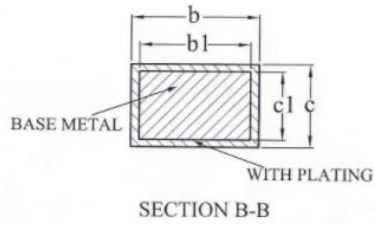
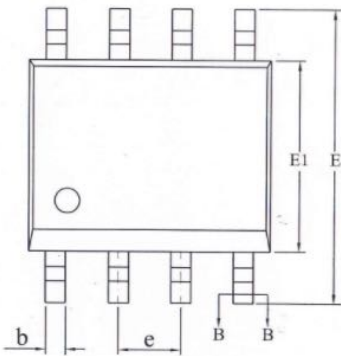
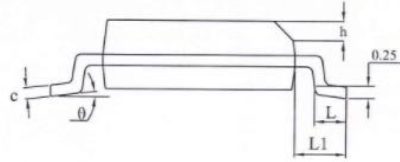
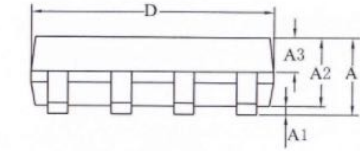

SYMBOL	MILLIMETER		
	MIN	NOM	MAX
A	—	—	1.75
A1	0.10	—	0.225
A2	1.30	1.40	1.50
A3	0.60	0.65	0.70
b	0.39	—	0.47
b1	0.38	0.41	0.44
c	0.20	—	0.24
c1	0.19	0.20	0.21
D	4.80	4.90	5.00
E	5.80	6.00	6.20
E1	3.80	3.90	4.00
e	1.27BSC		
h	0.25	—	0.50
L	0.50	—	0.80
L1	1.05REF		
θ	0	—	8°

△
△
△
△
△
△

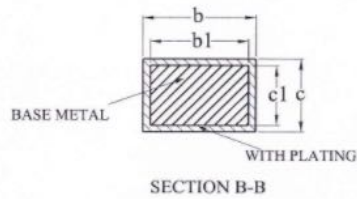
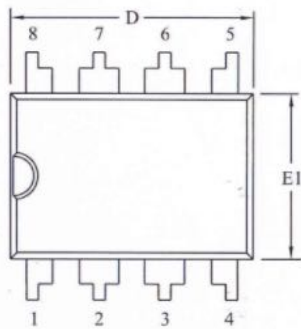
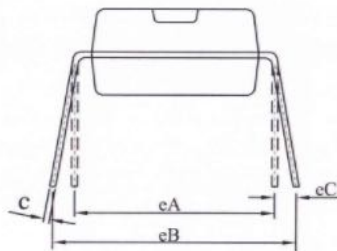
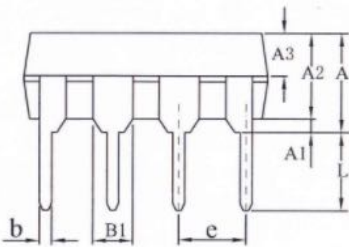

SYMBOL	MILLIMETER		
	MIN	NOM	MAX
A	3.60	3.80	4.00
A1	0.51	—	—
A2	3.20	3.30	3.40
A3	1.55	1.60	1.65
b	0.44	—	0.52
b1	0.43	0.46	0.49
B1	1.52REF		
c	0.25	—	0.29
c1	0.24	0.25	0.26
D	9.15	9.25	9.35
E1	6.25	6.35	6.45
e	2.54BSC		
eA	7.62REF		
eB	7.62	—	9.30
eC	0	—	0.84
L	3.00	—	—

△
△ △
△ △ △
△ △ △
△ △ △
△ △ △